

Country-by-Country Reporting XML Schema

User Guide for Tax Administrations

September 2017

Country-by-Country Reporting XML Schema: User Guide for Tax Administrations

Version 1.0.1 – September 2017



Please cite this publication as:

OECD (2017), Country-by-Country Reporting XML Schema: User Guide for Tax Administrations, OECD, www.oecd.org/tax/country-by-country-reporting-xml-schema-user-guide-for-tax-administrations.pdf

Photo credits: Cover © optimarc – Shutterstock.com

© OECD 2017

You can copy, download or print OECD content for your own use, and you can include excerpts from OECD publications, databases and multimedia products in your own documents, presentations, blogs, websites and teaching materials, provided that suitable acknowledgment of the source and copyright owner is given. All requests for public or commercial use and translation rights should be submitted to rights@oecd.org. Requests for permission to photocopy portions of this material for public or commercial use shall be addressed directly to the Copyright Clearance Center (CCC) at info@copyright.com or the Centre français d'exploitation du droit de copie (CFC) at contact@cfcopies.com.

Introduction

Action 13 of the OECD’s Action Plan on Base Erosion and Profit Shifting (BEPS) requires the development of *“rules regarding transfer pricing documentation to enhance transparency for tax administration, taking into consideration the compliance costs for business. The rules to be developed will include a requirement that MNEs provide all relevant governments with needed information on their global allocation of the income, economic activity and taxes paid among countries according to a common template”*.

In response to this requirement, a three-tiered standardised approach to transfer pricing documentation has been developed, including the requirement for MNEs with annual consolidated group revenue equal or exceeding EUR 750 million (or an approximately equivalent amount in domestic currency) to file a Country-by-Country (CbC) Report that will provide annually and for each Tax Jurisdiction in which they do business the amount of revenue, profit before income tax and income tax paid and accrued. It also requires MNEs to report their number of employees, stated capital, accumulated earnings and tangible assets in each Tax Jurisdiction. Finally, it requires MNEs to identify each entity within the group doing business in a particular Tax Jurisdiction and to provide an indication of the business activities each Constituent Entity engages in. The approved template for CbC Reports can be found in Appendix C.

CbC Reports should be filed in the Tax Jurisdiction of the Reporting Entity and shared between jurisdictions through automatic exchange of information, pursuant to government-to-government mechanisms such as the Multilateral Convention on Mutual Administrative Assistance in Tax Matters, Double Tax Conventions or Tax Information Exchange Agreements (TIEAs). In limited circumstances, secondary mechanisms, including local filing can be used as a backup.

In order to facilitate the swift and uniform implementation of CbC Reporting and with a view to accommodating the electronic preparation, filing and exchange of CbC Reports, the present CbC XML Schema and the related User Guide have been developed.

A schema is a data structure for electronically holding and transmitting information. XML, ‘extensible markup language’, is commonly used for this purpose. Examples are the OECD’s Common Reporting Standard XML

Schema, the United States' FATCA XML Schema and the European Union's Fisc 153 format.

This User Guide explains the information required to be included in each CbC data element to be reported in the CbC XML Schema v. 1.0.1. It also contains guidance on how to make corrections of data items within a file that can be processed automatically.

Compared to the first version of the CbC XML Schema (v.1.0), codes for designating stateless entities and stateless income (X5) have been added, as well as a new value (CBC611) to specify the Name of the MNE Group as part of the Additional Information element.

The definition of all capitalised terms used in this User Guide can be found in the final report on BEPS Action 13.

How the CbC User Guide links to the CbC XML Schema

This User Guide is divided into logical sections based on the schema and provides information on specific data elements and any attributes that describe that data element.

The Country-by-Country Reporting XML Schema Information sections are:

- I Message Header with the sender, recipient, message type, reporting period
- II The identifying information to be provided for each Constituent Entity
- III The body of the CbC XML Schema, containing the reportable information on the Reporting Entity and each Constituent Entity, as well as a summary of the activities of the MNE Group, as set out in the CbC reporting template.

The CbC XML Schema is designed to be used for the automatic exchange of CbC Reports between Competent Authorities. In addition, the CbC XML Schema may also be used for domestic reporting by Reporting Entities to their domestic tax authorities. Items relevant for domestic reporting only are shown in [*brackets*].

The requirement field for each data element and its attribute indicates whether the element is validation or optional in the CbC XML Schema.

“**Validation**” elements **MUST** be present for ALL data records in a file and an automated validation check can be undertaken. The sender should do a technical check of the data file content using XML tools to make sure all validation elements are present and, if they are not, a correction to the file should be made. The receiver may also check the presence of all validation elements and may reject the file in case such elements are missing. Some elements are shown as “**(Optional) Mandatory**”, indicating they are in principle required for CbC reporting, but only in certain instances, as further specified for the respective elements in this User Guide. Consequently, (Optional) Mandatory elements may be present in most (but not all) circumstances, so there cannot be a simple IT validation process to check these. For example, the Reporting Entity and CbC Reports elements are labelled as “Optional (Mandatory)”, indicating that both elements are in principle mandatory, unless one of the elements is left blank in the context of a correction of the other element (see the Corrections section below for further detail). Other “**Optional**” elements are, while recommended, not required to be provided and may in certain instances represent a choice

between one type or another, where one of them must be used (e.g. choice between address fix or address free).

Section V and VI of the CbC User Guide contain further guidance on the transliteration of information and corrections, respectively.

Appendix A to the CbC User Guide shows a diagrammatic representation of the CbC XML Schema with all its elements. The numbers next to the headings are the corresponding section numbers in the User Guide text, which provides further guidance on the information to be provided in each element.

Appendix B to the CbC User Guide contains a glossary of namespaces for the CbC XML Schema.

CbC XML Schema Information

I. Message Header

Information in the message header identifies the Competent Authority that is sending the message, as well as the Competent Authorities receiving the message. It specifies when the message was created, what period (normally a fiscal year) the report is for, and the nature of the report (original, corrected, supplemental, etc.).

| Element | Attribute | Size | Input Type | Requirement |
|-----------------|-----------|------|------------|-------------|
| SendingEntityIN | | | xsd:string | Optional |

[Although not used for exchanges between Competent Authorities in the context of CbC reporting, the Sending Entity IN element would be mandatory for domestic reporting and would identify the Reporting Entity reporting to the sending Competent Authority (e.g. by a domestic TIN or IN).]

| Element | Attribute | Size | Input Type | Requirement |
|---------------------|-----------|-------------|----------------------|-------------|
| TransmittingCountry | | 2-character | iso:CountryCode_Type | Validation |

This data element identifies the jurisdiction of the Competent Authority transmitting the message. It uses the 2-character alphabetic country code and country name list based on the ISO 3166-1 Alpha 2 standard, complemented by the X5 code for stateless entities and income.¹

[For domestic reporting this element would be the domestic country code.]

| Element | Attribute | Size | Input Type | Requirement |
|------------------|-----------|-------------|----------------------|-------------|
| ReceivingCountry | | 2-character | iso:CountryCode_Type | Validation |

1. The following disclaimer refers to all uses of the ISO country code list in the CbC XML Schema: For practical reasons, the list is based on the ISO 3166-1 country list. The use of this list does not imply the expression by the OECD of any opinion whatsoever concerning the legal status of the territories listed. Its content is without prejudice to the status of or sovereignty over any territory, to the delimitation of international frontiers and boundaries and to the name of any territory, city or area.

This data element identifies the jurisdiction(s) of the Competent Authority or Authorities that is(are) the intended recipient(s) of the message.

In the context of CbC reporting, all jurisdictions in which a Constituent Entity is found to be resident on the basis of the information provided by the Reporting Entity in the CbC Report should be entered in this field. It will be for the sending Competent Authority to make a determination as to which jurisdictions can actually receive the CbC Report for a given year, depending of the exchange relationships it has in effect for the purpose of CbC reporting. *[For domestic reporting this element would be the domestic country code.]*

| Element | Attribute | Size | Input Type | Requirement |
|-------------|-----------|------|--------------------------|-------------|
| MessageType | | | cbc:MessageType_EnumType | Validation |

This data element specifies the type of message being sent. The only allowable entry in this field is “CBC”.

| Element | Attribute | Size | Input Type | Requirement |
|----------|-----------|------|-----------------------|-------------------------|
| Language | | | iso:LanguageCode_Type | Optional (Mandatory) |

This data element specifies the language in which the content of the Additional Info element, if any, has been provided, by indicating the relevant language code pursuant to ISO 639 – Part 1 (ISO 639-1:2002). In accordance with the final report on BEPS Action 13, the language in which the CbC Report is to be submitted is determined by local law of the sending jurisdiction. With a view to allowing the most widespread use of the information contained in the CbC Report, the use of the English language is preferred, if permissible under such local law. See Section IV for further guidance on the transliteration of information.

| Element | Attribute | Size | Input Type | Requirement |
|---------|-----------|----------------------|-------------------------------------|-------------|
| Warning | | Max 4'000 characters | cbc:StringMaxLengthForLongText_Type | Optional |

This data element is a free text field allowing input of specific cautionary instructions about use of the CbC message content. If the reported data is for a period other than for a full fiscal year this information can be given here as narrative, e.g. “ten month period”. Equally, the fact that the message contains reports of MNE Groups with diverging fiscal years may be specified here.

| Element | Attribute | Size | Input Type | Requirement |
|---------|-----------|------|------------|-------------|
|---------|-----------|------|------------|-------------|

| | | |
|---------|------------|----------|
| Contact | xsd:string | Optional |
|---------|------------|----------|

This data element is a free text field allowing input of specific contact information for the sender of the message (i.e. the sending Competent Authority [*or the Reporting Entity in the context of domestic reporting*]).

| Element | Attribute | Size | Input Type | Requirement |
|--------------|-----------|------|------------|-------------|
| MessageRefID | | | xsd:string | Validation |

This data element is a free text field capturing the sender's unique identifying number (created by the sender) that identifies the particular message being sent. The identifier allows both the sender and receiver to identify the specific message later if questions or corrections arise. For exchanges of CbC Reports between Competent Authorities, the first part should be the country code of the jurisdiction of the sending Competent Authority, the second part the year to which the information relates, and the third part a unique identifier created by the sending jurisdiction.

[In case the CbC XML Schema is used for domestic reporting, the sending Reporting Entity should ensure that a unique identifier is created, which could be complemented by a Reporting Entity identification number, provided by the Competent Authority of the Tax Jurisdiction of the Reporting Entity.]

| Element | Attribute | Size | Input Type | Requirement |
|------------------|-----------|------|----------------------------------|-------------|
| MessageTypeIndic | | | cbc:CbcMessageTypeIndic_EnumType | Optional |

This data element allows the sender to define the type of message sent. This is an optional element as the DocTypeIndic element also identifies whether data is new or corrected (see Guidance on the Correction Process below). Messages must contain all new or all corrected data.

The possible values are:

- CBC401= The message contains new information
- CBC402= The message contains corrections for previously sent information

| Element | Attribute | Size | Input Type | Requirement |
|------------------|-----------|------|------------|-------------|
| CorrMessageRefID | | | xsd:string | Optional |

This data element is not used for CbC reporting.

| Element | Attribute | Size | Input Type | Requirement |
|---------|-----------|------|------------|-------------|
|---------|-----------|------|------------|-------------|

| | | |
|-----------------|----------|------------|
| ReportingPeriod | xsd:date | Validation |
|-----------------|----------|------------|

This data element identifies the last day of the reporting period (i.e. the fiscal year of the MNE Group) to which the message relates in YYYY-MM-DD format. For example, if the fiscal year of the MNE Group runs from 1 April 2016 to 31 March 2017, the entry would be “**2017-03-31**”. If exceptionally the reporting period does not correspond to a full 12-month fiscal year, the length of the reporting period should be indicated in the Warning element.

| Element | Attribute | Size | Input Type | Requirement |
|-----------|-----------|------|--------------|-------------|
| Timestamp | | | xsd:dateTime | Validation |

This data element identifies the date and time when the message was compiled. It is anticipated this element will be automatically populated by the host system. The format for use is YYYY-MM-DD'T'hh:mm:ss. Fractions of seconds are not used. Example: **2018-02-15T14:37:40**.

II. OrganisationParty_Type

This complex type is used to identify each of the Constituent Entities, including the Reporting Entity, on which information is to be provided as part of the CbC Report.

It comprises the following data elements:

| Element | Attribute | Size | Input Type | Requirement |
|----------------|-----------|-------------|----------------------|-------------|
| ResCountryCode | | 2-character | iso:CountryCode_Type | Validation |

| Element | Attribute | Size | Input Type | Requirement |
|---------|-----------|------------|--------------|-------------|
| TIN | | Min 1 char | cbc:TIN_Type | Validation |

| Element | Attribute | Size | Input Type | Requirement |
|---------|-----------|------------|-------------------------|-------------|
| IN | | Min 1 char | cbc:OrganisationIN_Type | Optional |

| Element | Attribute | Size | Input Type | Requirement |
|---------|-----------|------|---------------------------|-------------|
| Name | | | cbc:NameOrganisation_Type | Validation |

| Element | Attribute | Size | Input Type | Requirement |
|---------|-----------|------|------------------|-------------|
| Address | | | cbc:Address_Type | Optional |

IIa. ResCountryCode

| Element | Attribute | Size | Input Type | Requirement |
|----------------|-----------|-------------|----------------------|-------------|
| ResCountryCode | | 2-character | iso:CountryCode_Type | Validation |

This data element should contain the country code(s) of the Tax Jurisdiction of the Constituent Entity (or, in case of a permanent establishment that is a Constituent Entity, the jurisdiction in which such permanent establishment is subject to tax).

Iib. TIN (TIN_Type)

| Element | Attribute | Size | Input Type | Requirement |
|---------|-----------|------------|--------------|-------------|
| TIN | | Min 1 char | cbc:TIN_Type | Validation |

This data element provides the tax identification number (TIN) used by the tax administration of the Tax Jurisdiction of the Constituent Entity. In case the relevant Constituent Entity has a TIN that is used by the tax administration in its Tax Jurisdiction, such TIN is to be mandatorily provided, as to ensure the quality of the data, as well as the correct use thereof. In case a Constituent Entity does not have a TIN, the value “NOTIN” should be entered.

| Element | Attribute | Size | Input Type | Requirement |
|---------|-----------|-------------|----------------------|-------------------------|
| TIN | issuedBy | 2-character | iso:CountryCode_Type | Optional (Mandatory) |

This attribute describes the jurisdiction that issued the TIN.

Iic. Entity IN (OrganisationIN_Type)

| Element | Attribute | Size | Input Type | Requirement |
|---------|-----------|------------|-------------------------|-------------|
| IN | | Min 1 char | cbc:OrganisationIN_Type | Optional |

This data element can be provided (and repeated) if there are other INs available, such as a company registration number or a Global Entity Identification Number (EIN).

| Element | Attribute | Size | Input Type | Requirement |
|---------|-----------|-------------|----------------------|-------------|
| IN | issuedBy | 2-character | iso:CountryCode_Type | Optional |

This attribute describes the jurisdiction that issued the IN. If the issuing jurisdiction is not known then this element may be left blank.

| Element | Attribute | Size | Input Type | Requirement |
|---------|-----------|------|------------|-------------|
| IN | INType | | xsd:string | Optional |

This attribute defines the type of IN being sent (e.g. EIN).

IId. Organisation Name

| Element | Attribute | Size | Input Type | Requirement |
|---------|-----------|------|---------------------------|-------------|
| Name | | | cbc:NameOrganisation_Type | Validation |

This element should contain the full legal name of the Constituent Entity, including the domestic designation for the legal form, as indicated in its articles of incorporation or any similar document. In case the Constituent Entity is a permanent establishment, the name of the Constituent Entity should be followed by “(P.E.)”.

IIf. Address_Type

There are two alternative options for Address type in the CbC XML schema – AddressFix and AddressFree. In principle, AddressFix should be in all cases, unless the Reporting Entity is not in a position to define the various parts of a Constituent Entity’s address, in which case the AddressFree type may be used.

While the CbC reporting template does not require that the address of each Constituent Entity be reported, it is strongly recommended that this information is provided, as to ensure that the data in the CbC XML Schema is of a high quality, as to ensure that the data is accurately matched and appropriately used by the receiving jurisdiction(s).

This data element is the permanent residence address of a Constituent Entity.

| Element | Attribute | Size | Input Type | Requirement |
|-------------|-----------|-------------|----------------------|-------------|
| CountryCode | | 2-character | iso:CountryCode_Type | Validation |

This data element provides the country code associated with the Constituent Entity.

| Element | Attribute | Size | Input Type | Requirement |
|-------------|-----------|------|------------|-------------|
| AddressFree | | | xsd:string | Optional |

This data element allows input of address information in free text. If the data is entered in 'AddressFree', all available address details shall be presented as one string of bytes, with blanks, slashes or carriage returns being used as a delimiter between parts of the address. This option should only be used if the data cannot be presented in the AddressFix format.

NOTE: If AddressFix is selected, there will be the option of inputting the full street address of a Constituent Entity in the AddressFree element rather than using the related fixed elements. In this case, the city, subentity,

and postal code information should still be entered in the appropriate fixed elements.

| Element | Attribute | Size | Input Type | Requirement |
|-------------|------------------|------|-----------------------------------|-------------|
| AddressType | legalAddressType | | stf:OECDLegalAddressType_EnumType | Optional |

OECDLegalAddressType_EnumType

This is a datatype for an attribute to an address. It serves to indicate the legal character of that address (residential, business, etc.)

The possible values are:

- OECD301=residentialOrBusiness
- OECD302=residential
- OECD303=business
- OECD304=registeredOffice
- OECD305=unspecified

| Element | Attribute | Size | Input Type | Requirement |
|---------|-----------|------|------------|-------------|
| Street | | | xsd:string | Optional |

| Element | Attribute | Size | Input Type | Requirement |
|--------------------|-----------|------|------------|-------------|
| BuildingIdentifier | | | xsd:string | Optional |

| Element | Attribute | Size | Input Type | Requirement |
|-----------------|-----------|------|------------|-------------|
| SuiteIdentifier | | | xsd:string | Optional |

| Element | Attribute | Size | Input Type | Requirement |
|-----------------|-----------|------|------------|-------------|
| FloorIdentifier | | | xsd:string | Optional |

| Element | Attribute | Size | Input Type | Requirement |
|--------------|-----------|------|------------|-------------|
| DistrictName | | | xsd:string | Optional |

| Element | Attribute | Size | Input Type | Requirement |
|---------|-----------|------|------------|-------------|
| POB | | | xsd:string | Optional |

| Element | Attribute | Size | Input Type | Requirement |
|----------|-----------|------|------------|-------------|
| PostCode | | | xsd:string | Optional |

| Element | Attribute | Size | Input Type | Requirement |
|---------|-----------|------|------------|-------------|
| City | | | xsd:string | Validation |

| Element | Attribute | Size | Input Type | Requirement |
|------------------|-----------|------|------------|-------------|
| CountrySubentity | | | xsd:string | Optional |

The above data elements comprise the AddressFix type.

III. CbC Body

The CbC Body contains the information on the Constituent Entities, including the Reporting Entity, of the MNE Group for which a CbC Report is filed, as well as the key indicators of both the MNE Group as a whole and the individual Constituent Entities, as foreseen in the CbC reporting template.

| Element | Attribute | Size | Input Type | Requirement |
|---------|-----------|------|------------------|-------------|
| CbcBody | | | cbc:CbcBody_Type | Validation |

The CbC Body element is composed of the following elements:

| Element | Attribute | Size | Input Type | Requirement |
|-----------------|-----------|------|-------------------------------------|-------------------------|
| ReportingEntity | | | cbc:CorrectableReportingEntity_Type | Optional (Mandatory) |

The Reporting Entity element contains the identifying information for the entity of the MNE Group that ensures the preparation and filing of the CbC Report.

| Element | Attribute | Size | Input Type | Requirement |
|------------|-----------|------|-------------------------------|-------------------------|
| CbcReports | | | cbc:CorrectableCbcReport_Type | Optional (Mandatory) |

The CbC Reports element contains, for each Tax Jurisdiction in which the MNE Group operates, the summary of key indicators, as well as a list of all Constituent Entities and their business activities.

| Element | Attribute | Size | Input Type | Requirement |
|----------------|-----------|------|------------------------------------|-------------|
| AdditionalInfo | | | cbc:CorrectableAdditionalInfo_Type | Optional |

The Additional Info element allows entering any additional information on the CbC Report that the Reporting Entity wishes to make available to the receiving Competent Authorities in a free text format.

IIIa. ReportingEntity

| Element | Attribute | Size | Input Type | Requirement |
|-----------------|-----------|------|-------------------------------------|-------------------------|
| ReportingEntity | | | cbc:CorrectableReportingEntity_Type | Optional (Mandatory) |

As indicated above, this data element identifies the Reporting Entity and its role in the context of CbC reporting. It may be left blank in case a correction or deletion is carried out (see further guidance in the Corrections section below). The element is composed of:

| Element | Attribute | Size | Input Type | Requirement |
|---------|-----------|------|----------------------------|-------------|
| Entity | | | cbc:OrganisationParty_Type | Validation |

This element contains the identifying information for the Reporting Entity. The Entity element uses the OrganisationParty_Type to provide the identifying information.

| Element | Attribute | Size | Input Type | Requirement |
|---------------|-----------|------|-------------------------------|-------------|
| ReportingRole | | | cbc:CbcReportingRole_EnumType | Validation |

The Reporting Role element specifies the role of the Reporting Entity with respect to the filing of the CbC Report. Possible values are:

- CBC701 – Ultimate Parent Entity
- CBC702 – Surrogate Parent Entity
- [CBC703 – Local Filing] – *the Local Filing value is only to be used in case the Tax Jurisdiction of the Reporting Entity has mandated the use of the CbC XML Schema for local filing of CbC Reports and if such local filing is required on the basis of the domestic legislation of the jurisdiction of the Reporting Entity.*

| Element | Attribute | Size | Input Type | Requirement |
|---------|-----------|------|------------------|-------------|
| DocSpec | | | stf:DocSpec_Type | Validation |

DocSpec identifies the particular report within the CbC message being transmitted. It permits the identification of reports requiring correction (for further guidance see the Corrections section below).

IIIb. CbC Reports

As outlined above, the CbC Reports element contains, for each Tax Jurisdiction in which the MNE Group operates, the summary of key indicators, as well as a list of all Constituent Entities and their business

activities. The CbC Reports element should be repeated for each Tax Jurisdiction in which the MNE Group operates through one or more Constituent Entities. It may be left blank in case a correction is carried out on the Reporting Entity element (see further guidance in the Corrections section below).

Any amounts should be provided in full units, i.e. without decimals, and any negative values should be identified by entering a “-“ in front of the amount (e.g. USD -1000).

| Element | Attribute | Size | Input Type | Requirement |
|------------|-----------|------|-------------------------------|-------------------------|
| CbcReports | | | cbc:CorrectableCbcReport_Type | Optional (Mandatory) |

The CbC Reports element is composed of:

| Element | Attribute | Size | Input Type | Requirement |
|---------|-----------|------|------------------|-------------|
| DocSpec | | | stf:DocSpec_Type | Validation |

DocSpec identifies the particular report within the CbC message being transmitted. It permits the identification of reports requiring correction (for further guidance see the Corrections section below).

| Element | Attribute | Size | Input Type | Requirement |
|----------------|-----------|-------------|----------------------|-------------|
| ResCountryCode | | 2-character | iso:CountryCode_Type | Validation |

This data element should contain the country code of the Tax Jurisdiction for which the summary of key indicators and the list of Constituent Entities and their business activities is prepared.

| Element | Attribute | Size | Input Type | Requirement |
|---------|-----------|------|------------|-------------|
| Summary | | | | Validation |

The Summary element contains the key indicators of the MNE Group’s business activities in a relevant Tax Jurisdiction, as foreseen by the CbC reporting template.

| Element | Attribute | Size | Input Type | Requirement |
|---------------|-----------|------|----------------------------|-------------|
| ConstEntities | | | cbc:ConstituentEntity_Type | Validation |

The ConstEntities element contains the list of Constituent Entities (including the Reporting Entity) operating in a Tax Jurisdiction, as well as their business activities, as foreseen in the CbC reporting template.

IIIb. CbC Reports – Summary

| Element | Attribute | Size | Input Type | Requirement |
|---------|-----------|------|------------|-------------|
| Summary | | | | Validation |

The Summary element, setting out the key indicators for the MNE Group’s business activities in a particular Tax Jurisdiction, is composed of:

| Element | Attribute | Size | Input Type | Requirement |
|----------|-----------|------|------------|-------------|
| Revenues | | | | Validation |

Additional detail on the information to be provided in the Revenues element and its sub elements is available further below.

| Element | Attribute | Size | Input Type | Requirement |
|--------------|-----------|------|------------------|-------------|
| ProfitOrLoss | | | cbc:MonAmnt_Type | Validation |

In the Profit or Loss element, the sum of the profit or loss before income tax for all Constituent Entities resident for tax purposes in the relevant Tax Jurisdiction should be entered. The profit or loss before income tax should include all extraordinary income and expense items.

| Element | Attribute | Size | Input Type | Requirement |
|--------------|-----------|--------------|-------------------|-------------|
| ProfitOrLoss | currCode | 3 characters | iso:currCode_Type | Validation |

All amounts must be accompanied by the appropriate 3 character currency code based on the ISO 4217 Alpha 3 Standard.

| Element | Attribute | Size | Input Type | Requirement |
|---------|-----------|------|------------------|-------------|
| TaxPaid | | | cbc:MonAmnt_Type | Validation |

In the Tax Paid element, the total amount of income tax actually paid during the relevant fiscal year by all Constituent Entities resident for tax purposes in the relevant Tax Jurisdiction should be provided. Taxes paid should include cash taxes paid by a Constituent Entity to the residence Tax Jurisdiction and to all other Tax Jurisdictions. Taxes paid should include withholding taxes paid by other entities (associated enterprises and independent enterprises) with respect to payments to the Constituent Entity. Thus, if company A resident in Tax Jurisdiction A earns interest in Tax Jurisdiction B, the tax withheld in Tax Jurisdiction B should be reported by company A.

| Element | Attribute | Size | Input Type | Requirement |
|---------|-----------|--------------|-------------------|-------------|
| TaxPaid | currCode | 3 characters | iso:currCode_Type | Validation |

All amounts must be accompanied by the appropriate 3 character currency code based on the ISO 4217 Alpha 3 Standard.

| Element | Attribute | Size | Input Type | Requirement |
|------------|-----------|------|------------------|-------------|
| TaxAccrued | | | cbc:MonAmnt_Type | Validation |

In the Tax Accrued element, the sum of the accrued current tax expense recorded on taxable profits or losses of the year of reporting of all Constituent Entities resident for tax purposes in the relevant Tax Jurisdiction should be provided. The current tax expense should reflect only operations in the current year and should not include deferred taxes or provisions for uncertain tax liabilities.

| Element | Attribute | Size | Input Type | Requirement |
|------------|-----------|--------------|-------------------|-------------|
| TaxAccrued | currCode | 3 characters | iso:currCode_Type | Validation |

All amounts must be accompanied by the appropriate 3 character currency code based on the ISO 4217 Alpha 3 Standard.

| Element | Attribute | Size | Input Type | Requirement |
|---------|-----------|------|------------------|-------------|
| Capital | | | cbc:MonAmnt_Type | Validation |

In the Capital element, the sum of the stated capital of all Constituent Entities resident for tax purposes in the relevant Tax Jurisdiction should be provided. With regard to permanent establishments, the stated capital should be reported by the legal entity of which it is a permanent establishment, unless there is a defined capital requirement in the permanent establishment Tax Jurisdiction for regulatory purposes. In such case, the capital attributed to a permanent establishment may be further specified in the Additional Info element.

| Element | Attribute | Size | Input Type | Requirement |
|---------|-----------|--------------|-------------------|-------------|
| Capital | currCode | 3 characters | iso:currCode_Type | Validation |

All amounts must be accompanied by the appropriate 3 character currency code based on the ISO 4217 Alpha 3 Standard.

| Element | Attribute | Size | Input Type | Requirement |
|----------|-----------|------|------------------|-------------|
| Earnings | | | cbc:MonAmnt_Type | Validation |

In the Earnings element, the sum of the total accumulated earnings of all Constituent Entities resident for tax purposes in the relevant Tax Jurisdiction as of the end of the year should be provided. With regard to permanent establishments, accumulated earnings should be reported by the legal entity of which it is a permanent establishment.

| Element | Attribute | Size | Input Type | Requirement |
|----------|-----------|--------------|-------------------|-------------|
| Earnings | currCode | 3 characters | iso:currCode_Type | Validation |

All amounts must be accompanied by the appropriate 3 character currency code based on the ISO 4217 Alpha 3 Standard.

| Element | Attribute | Size | Input Type | Requirement |
|-------------|-----------|------|-------------|-------------|
| NbEmployees | | | xsd:integer | Validation |

In the Nb Employees element, the total number of employees on a full-time equivalent (FTE) basis of all Constituent Entities resident for tax purposes in the relevant Tax Jurisdiction should be provided. The number of employees may be reported as of the year-end, on the basis of average employment levels for the year, or on any other basis consistently applied across Tax Jurisdictions and from year to year. For this purpose, independent contractors participating in the ordinary operating activities of the Constituent Entity may be reported as employees. Reasonable rounding or approximation of the number of employees is permissible, providing that such rounding or approximation does not materially distort the relative distribution of employees across the various Tax Jurisdictions. Consistent approaches should be applied from year to year and across entities.

| Element | Attribute | Size | Input Type | Requirement |
|---------|-----------|------|------------------|-------------|
| Assets | | | cbc:MonAmnt_Type | Validation |

In the Assets elements, the sum of the net book values of tangible assets of all Constituent Entities resident for tax purposes in the relevant Tax Jurisdiction should be provided. With regard to permanent establishments, assets should be reported by reference to the Tax Jurisdiction in which the permanent establishment is situated. Tangible assets for this purpose do not include cash or cash equivalents, intangibles, or financial assets.

| Element | Attribute | Size | Input Type | Requirement |
|---------|-----------|--------------|-------------------|-------------|
| Assets | currCode | 3 characters | iso:currCode_Type | Validation |

All amounts must be accompanied by the appropriate 3 character currency code based on the ISO 4217 Alpha 3 Standard.

IIIb. CbC Reports – Summary – Revenues

| Element | Attribute | Size | Input Type | Requirement |
|----------|-----------|------|------------|-------------|
| Revenues | | | | Validation |

In the Revenues element, the following information should be entered:

| Element | Attribute | Size | Input Type | Requirement |
|-----------|-----------|------|------------------|-------------|
| Unrelated | | | cbc:MonAmnt_Type | Validation |

In the Unrelated element the sum of revenues of all the Constituent Entities of the MNE Group in the relevant Tax Jurisdiction generated from transactions with independent parties should be indicated. Revenues should include revenues from sales of inventory and properties, services, royalties, interest, premiums and any other amounts. Revenues should exclude payments received from other Constituent Entities that are treated as dividends in the payor's Tax Jurisdiction.

| Element | Attribute | Size | Input Type | Requirement |
|-----------|-----------|--------------|-------------------|-------------|
| Unrelated | currCode | 3 characters | iso:currCode_Type | Validation |

All amounts must be accompanied by the appropriate 3 character currency code based on the ISO 4217 Alpha 3 Standard.

| Element | Attribute | Size | Input Type | Requirement |
|---------|-----------|------|------------------|-------------|
| Related | | | cbc:MonAmnt_Type | Validation |

In the Related element the sum of revenues of all the Constituent Entities of the MNE Group in the relevant Tax Jurisdiction generated from transactions with associated enterprises is indicated. Revenues should include revenues from sales of inventory and properties, services, royalties, interest, premiums and any other amounts. Revenues should exclude payments received from other Constituent Entities that are treated as dividends in the payor's Tax Jurisdiction.

| Element | Attribute | Size | Input Type | Requirement |
|---------|-----------|--------------|-------------------|-------------|
| Related | currCode | 3 characters | iso:currCode_Type | Validation |

All amounts must be accompanied by the appropriate 3 character currency code based on the ISO 4217 Alpha 3 Standard.

| Element | Attribute | Size | Input Type | Requirement |
|---------|-----------|------|------------------|-------------|
| Total | | | cbc:MonAmnt_Type | Validation |

In the Total element the sum of the Unrelated and Related elements should be entered.

| Element | Attribute | Size | Input Type | Requirement |
|---------|-----------|--------------|-------------------|-------------|
| Total | currCode | 3 characters | iso:currCode_Type | Validation |

All amounts must be accompanied by the appropriate 3 character currency code based on the ISO 4217 Alpha 3 Standard.

IIIb. CbC Reports – Constituent Entities

| Element | Attribute | Size | Input Type | Requirement |
|---------------|-----------|------|----------------------------|-------------|
| ConstEntities | | | cbc:ConstituentEntity_Type | Validation |

The ConstEntities element is to be repeated for each Constituent Entity (including the Reporting Entity, if applicable) that is resident for tax purposes or subject to tax as a permanent establishment in the relevant Tax Jurisdiction and is composed of:

| Element | Attribute | Size | Input Type | Requirement |
|-------------|-----------|------|----------------------------|-------------|
| ConstEntity | | | cbc:OrganisationParty_Type | Validation |

In the ConstEntity element the identifying information for a Constituent Entity should be entered, using the OrganisationParty_Type.

| Element | Attribute | Size | Input Type | Requirement |
|-------------------|-----------|-------------|----------------------|-------------------------|
| IncorpCountryCode | | 2-character | iso:CountryCode_Type | Optional (Mandatory) |

In the IncorpCountryCode element, the Tax Jurisdiction under whose laws a Constituent Entity of the MNE Group is organised or incorporated should be indicated, if such Tax Jurisdiction is different from the Tax Jurisdiction of residence of the Constituent Entity.

| Element | Attribute | Size | Input Type | Requirement |
|---------------|-----------|------|---------------------------------|-------------|
| BizActivities | | | cbc:CbcBizActivityType_EnumType | Validation |

In the BizActivities element, the nature of the main business activity(ies) carried out by a Constituent Entity in the relevant Tax Jurisdiction should be specified, by selecting at least one of the following codes:

- CBC501 – Research and Development
- CBC502 – Holding or Managing intellectual property
- CBC503 – Purchasing or Procurement
- CBC504 – Manufacturing or Production
- CBC505 – Sales, Marketing or Distribution
- CBC506 – Administrative, Management or Support Services
- CBC507 – Provision of Services to unrelated parties
- CBC508 – Internal Group Finance
- CBC509 – Regulated Financial Services
- CBC510 – Insurance
- CBC511 – Holding shares or other equity instruments
- CBC512 – Dormant
- CBC513 – Other

CBC 513 – Other should only be selected, in case the business activities of the Constituent Entity cannot be accurately reflected through the selection of one or more of the other codes. In case the CBC513 – Other code is selected, further information as to the business activities of the Constituent Entity is to be provided in the Other Entity Info element. Care should be given that, in instances where the BizActivities element is corrected, an according correction is also carried out in the Other Entity Info element, in case related information has been provided in that element.

| Element | Attribute | Size | Input Type | Requirement |
|-----------------|-----------|----------------------|-------------------------------------|-------------|
| OtherEntityInfo | | Max 4'000 characters | cbc:StringMaxLengthForLongText_Type | Optional |

In the Other Entity Info element any further relevant information relating to a specific Constituent Entity may be entered in a free text format. In case additional information does not solely relate to a specific Constituent Entity, but also has relevance for the MNE Group as a whole, such information should instead be provided in the Additional Info element.

IIIc. Additional Info

| Element | Attribute | Size | Input Type | Requirement |
|----------------|-----------|------|------------------------------------|-------------|
| AdditionalInfo | | | cbc:CorrectableAdditionalInfo_Type | Optional |

The Additional Info element allows any further brief information or explanation to be entered that is deemed necessary or that would facilitate the understanding of the compulsory information provided in the other elements of the CbC XML Schema in a free text format, provided such information does not solely relate to a specific Constituent Entity, in which case the information should be entered in the Other Entity Info element of the concerned Constituent Entity. However, information entered in the Additional Info element may be “tagged” as set out below, with a view to facilitating the association of the information provided to particular jurisdictions and/or specific elements of the Summary element of the CbC Report.

The Additional Info element is composed of:

| Element | Attribute | Size | Input Type | Requirement |
|---------|-----------|------|------------------|-------------|
| DocSpec | | | stf:DocSpec_Type | Validation |

DocSpec identifies the particular report within the CbC message being transmitted. It permits the identification of reports requiring correction (for further guidance see the Corrections section below).

| Element | Attribute | Size | Input Type | Requirement |
|-----------|-----------|----------------------|-------------------------------------|-------------|
| OtherInfo | | Max 4'000 characters | cbc:StringMaxLengthForLongText_Type | Optional |

The Other Info element allows additional information to be entered in a free text format. Per entry, a maximum of 4'000 characters are allowed. In case more space is needed, the Additional Info element may be repeated, as required.

| Element | Attribute | Size | Input Type | Requirement |
|----------------|-----------|-------------|----------------------|-------------|
| ResCountryCode | | 2-character | iso:CountryCode_Type | Optional |

For each Additional Info element, it is possible to indicate that the information provided specifically relates to one or more jurisdictions. In that case the relevant country codes should be entered in the ResCountryCode element.

| Element | Attribute | Size | Input Type | Requirement |
|------------|-----------|------|--|-------------|
| SummaryRef | | | cbc:CbcSummaryListElementsType e_EnumType | Optional |

In addition, it is possible to indicate, for each Additional Info element, that the information provided specifically relates to one or more particular elements of the Summary element by selecting one or more of the corresponding values below. By doing so, the information contained in the relevant Additional Info element will be “tagged”, therewith facilitating the review of the CbC Report by the receiving jurisdiction(s).

The possible values, reflecting the structure of the Summary element, are:

- CBC601 – Revenues – Unrelated
- CBC602 – Revenues – Related
- CBC603 – Revenues – Total
- CBC604 – Profit or Loss
- CBC605 – Tax Paid
- CBC606 – Tax Accrued
- CBC607 – Capital
- CBC608 – Earnings
- CBC609 – Number of Employees
- CBC610 – Assets
- CBC611 - Name of MNE Group

IV. Currency

All amounts provided in the Country-by-Country Report should be reported in one and the same currency, being the currency of the Reporting MNE. If statutory financial statements are used as the basis for reporting, all amounts should be translated to the stated functional currency of the Reporting MNE at the average exchange rate for the year stated in the Additional Info element.

V. Transliteration

Where transliteration is required because sending and receiving jurisdictions do not use a common alphabet, Competent Authorities may agree how they will undertake such transliteration. If there is no such agreement, then a sending jurisdiction should, if so requested, transliterate from its own non-Latin domestic alphabet or literation to the Latin alphabet aligned with international standards for transliteration, as specified in ISO 8859. The sending jurisdiction may send designatory data (e.g. name or address) in both its non-Latin domestic alphabet or literation and separately in the Latin alphabet within each record if it so chooses. A receiving jurisdiction should also be prepared to transliterate from the Latin alphabet to its own non-Latin domestic alphabet or literation.

VI. Corrections

Introduction

In case the Reporting Entity and/or the sending jurisdiction becomes aware of inaccurate information, be it in relation to the Reporting Entity's identification information, or be it in relation to the information provided on the Constituent Entities and their business activities or the summary of the activities of the MNE Group in a Tax Jurisdiction, a correction will need to be made. As long as the error is discovered prior to the filing of the CbC Report by the Reporting Entity for a given fiscal year, no correction, as set out in this section, would be required.

However, in case an error is discovered after the filing of the CbC Report, adjustments to part of the CbC report will need to be made, in accordance with the guidance set out in this section.

In order to facilitate a targeted reporting of corrections, the CbC XML Schema is split into a number of correctable types, allowing correcting specific parts of the CbC Report without needing to resubmit the entire CbC Report. Such correctable types include the top-level elements Reporting Entity, CbC Reports and Additional Info.

Technical Guidance

This section describes how to make automatic corrections by sending a file of corrected data that can be processed in the same systems as the original data that was received. Reference to corrections in this section also includes deletion of records.

In order to identify the elements to correct, the top-level elements Reporting Entity, CbC Reports and AdditionalInfo include an element of the DocSpec_Type, which contains the necessary information for corrections. *DocSpec Type*

| Element | Attribute | Size | Input Type | Requirement |
|---------|-----------|------|------------------|-------------|
| DocSpec | | | stf:DocSpec_Type | Validation |

DocSpec identifies the particular report within the CbC message being transmitted. It permits the identification of reports requiring correction. The DocSpec element is composed of the following:

| Element | Attribute | Size | Input Type | Requirement |
|--------------|-----------|------|-------------------------------|-------------|
| DocTypeIndic | | | stf:OECDDocTypeIndic_EnumType | Validation |

This element specifies the type of data being submitted. Allowable entries are:

- OECD0 = Resent Data
- OECD1 = New Data
- OECD2 = Corrected Data
- OECD3 = Deletion of Data
- OECD10 = Resent Test Data
- OECD11 = New Test Data
- OECD12 = Corrected Test Data
- OECD13 = Deletion of Test Data

A corrected message can either contain new records (OECD1) or corrections and/or deletions (OECD2 and OECD3), but should not contain a mixture of both.

The resend option (OECD 0) should only be used for the Reporting Entity element, in case new information is provided in either the CbC Reports and/or the Additional Info elements and the Reporting Entity element has already been sent.

In case the information in either the Reporting Entity, the CbC Reports or the Additional Info element is not altered, such uncorrected element may be left blank.

The codes OECD10 through OECD13 must only be used during agreed testing periods or on the basis of a bilateral agreement on testing. This is to ensure that the competent authorities avoid test data becoming mingled with ‘live’ data.

| Element | Attribute | Size | Input Type | Requirement |
|----------|-----------|------------------|------------|-------------|
| DocRefID | | Min. 1 character | xsd:string | Validation |

The DocRefID is a unique identifier for the document (i.e. one record and all its children data elements). An element containing a correction (or deletion) must have a new unique DocRefID for future reference.

| Element | Attribute | Size | Input Type | Requirement |
|--------------|-----------|------------------|------------|-------------|
| CorrDocRefID | | Min. 1 character | xsd:string | Optional |

The CorrDocRefID references the DocRefID of the element to be corrected or deleted. It must always refer to the latest reference of the record (DocRefID) that was sent.

In this way, a series of corrections or amendments can be handled as each correction completely replaces the previous version. The CbC Correction examples below show how this works in practice.

| Element | Attribute | Size | Input Type | Requirement |
|------------------|-----------|------------------|------------|-------------|
| CorrMessageRefID | | Min. 1 character | xsd:string | Optional |

Since the DocRefID is unique in space and time, this element is not used for CbC Reports at the DocSpec level.

Uniqueness of MessageRefID and DocRefID

In order to ensure that a message and a record can be identified and corrected, the MessageRefID and DocRefID must be unique in space and time (i.e. there must be no other message or record in existence that has the same reference identifier).

The MessageRefID identifier can contain whatever information the sender uses to allow identification of the particular record but should start with the country code of the sending jurisdiction, followed by the year to which the data relates and then a dash before a unique identifier. *[In case the CbC XML Schema is used for domestic reporting, the sending Reporting Entity should ensure that a unique identifier is created in line with the above explanations, which could be complemented by a Reporting Entity identification number, provided by the Competent Authority of the Tax Jurisdiction of the Reporting Entity.]*

e.g. NL2017-123456789

This MessageRefID indicates that the Netherlands is the country of the sending Competent Authority, that the information relates to the fiscal year 2017 [*of the Reporting Entity*], and that the unique identifier is “123456789”.

The unique identifier in the DocRefID is used by the sending Competent Authority [*or the Reporting Entity*] to identify a unique record and is composed of the country code of the sending jurisdiction, followed by the year to which the data relates and then a dash before a unique identifier.

e.g. LU2019-286abc123xyz

This DocRefID indicates that Luxembourg is the sending country, the data relates to the fiscal year 2019 [*of the Reporting Entity*] and the unique identifier is “286abc123xyz”.

MessageSpec, Corrections and Cancellations

Correction messages must have their own unique MessageRefID so they can also be corrected in the future. There is no equivalent for the DocSpecIndic when it comes to messages as a whole.

To cancel a complete message, the MessageSpec.CorrMessageRefID should not be used. Instead, a correction message should be sent deleting all records of the erroneous message in these instances.

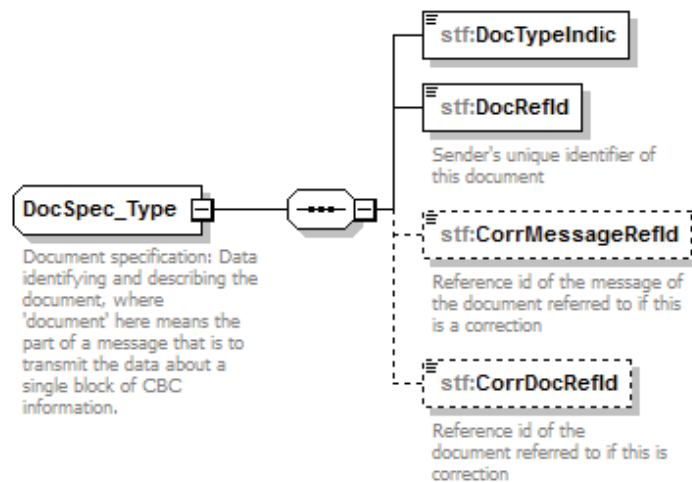

Generated by XMLSpy

www.altova.com

The following examples show how the `DocSpec_Type` elements are used to correct one or multiple parts of data previously sent.

CbC Correction examples

First example: a correction is made in relation to the Summary for a CbC Report. The correction is to be made in the TaxPaid field.

The correction file is sent from France (containing only corrections, not a mix of new and corrected data).

MessageRefID: FR2017-FranceNationalPart00001

For this Correction, the whole CbC Report must be resubmitted with all the Summary and ConstEntities information. The Reporting Entity element needs to be resubmitted only in case this information needs to be corrected (otherwise it should be omitted). The content of the Additional Info and Other Entity Info elements must be verified with respect to its accuracy and corrected, if needed. In case no changes are to be made to the Additional Info element(s), it should be omitted.

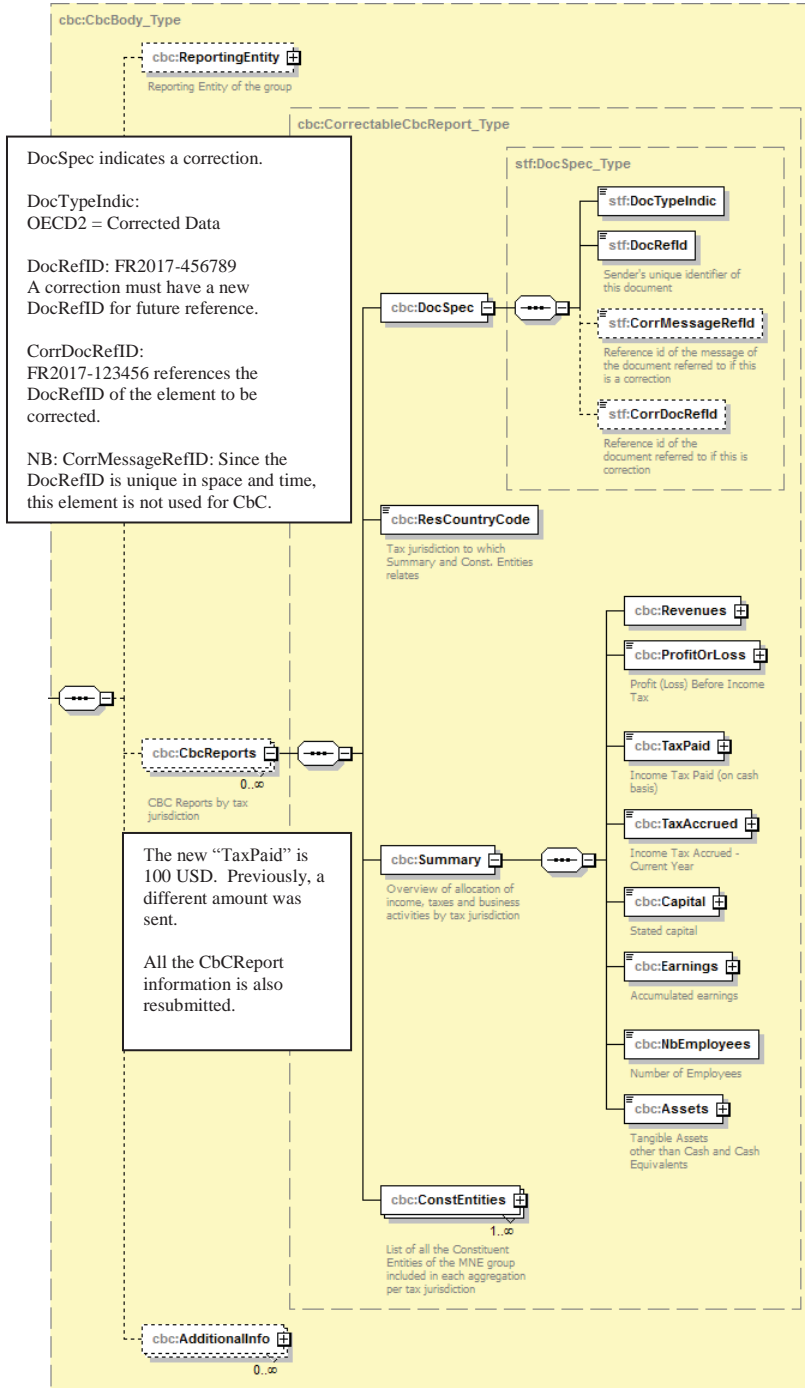

Second example: a correction is made regarding multiple identification items for a Constituent Entity (e.g. name and address), but no Summary information needs to be changed. The correction is made to an already corrected record (so it must reference the latest DocRefID: FR2017-456789).

For this Correction, the whole CbC Report must be resubmitted with all Summary (even if there is no change to the Summary) and ConstEntities information. The Reporting Entity element needs to be resubmitted only in case this information needs to be corrected (otherwise it should be omitted). The content of the Additional Info and Other Entity Info elements must be verified with respect to its accuracy and corrected, if needed. In case no changes are to be made to the Additional Info element(s), it should be omitted.

MessageRefID: FR2017-FranceNationalPart00002

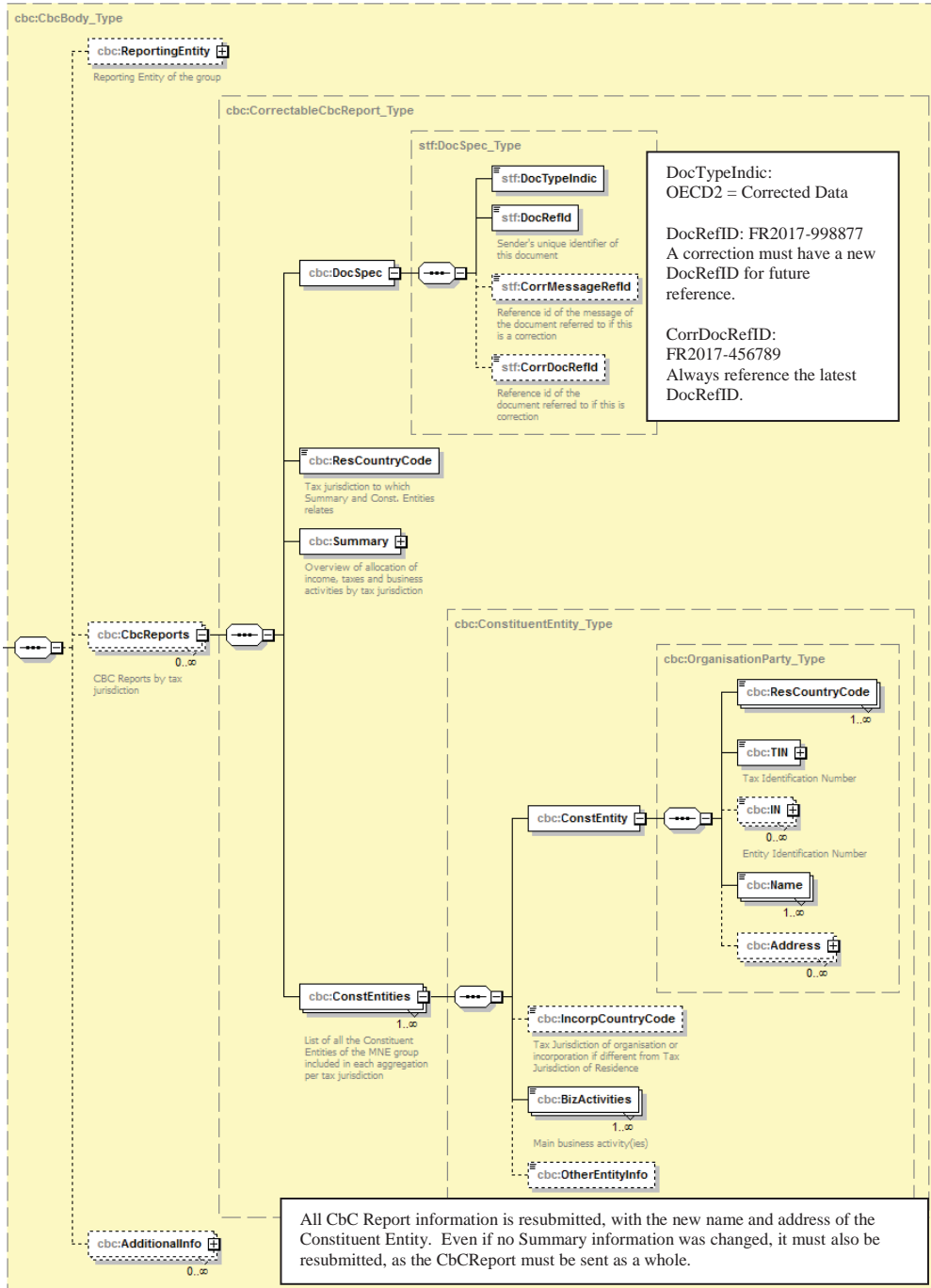

Third example: a correction is made only with respect to the Reporting Entity; no CbC Report or Additional Info data needs to be corrected. The correction must reference the Reporting Entity element to be corrected via its DocRefID (in this example, assume the previous Reporting Entity DocRefID was FR2017-333331).

MessageRefID: FR2017-FranceNationalPart00003.

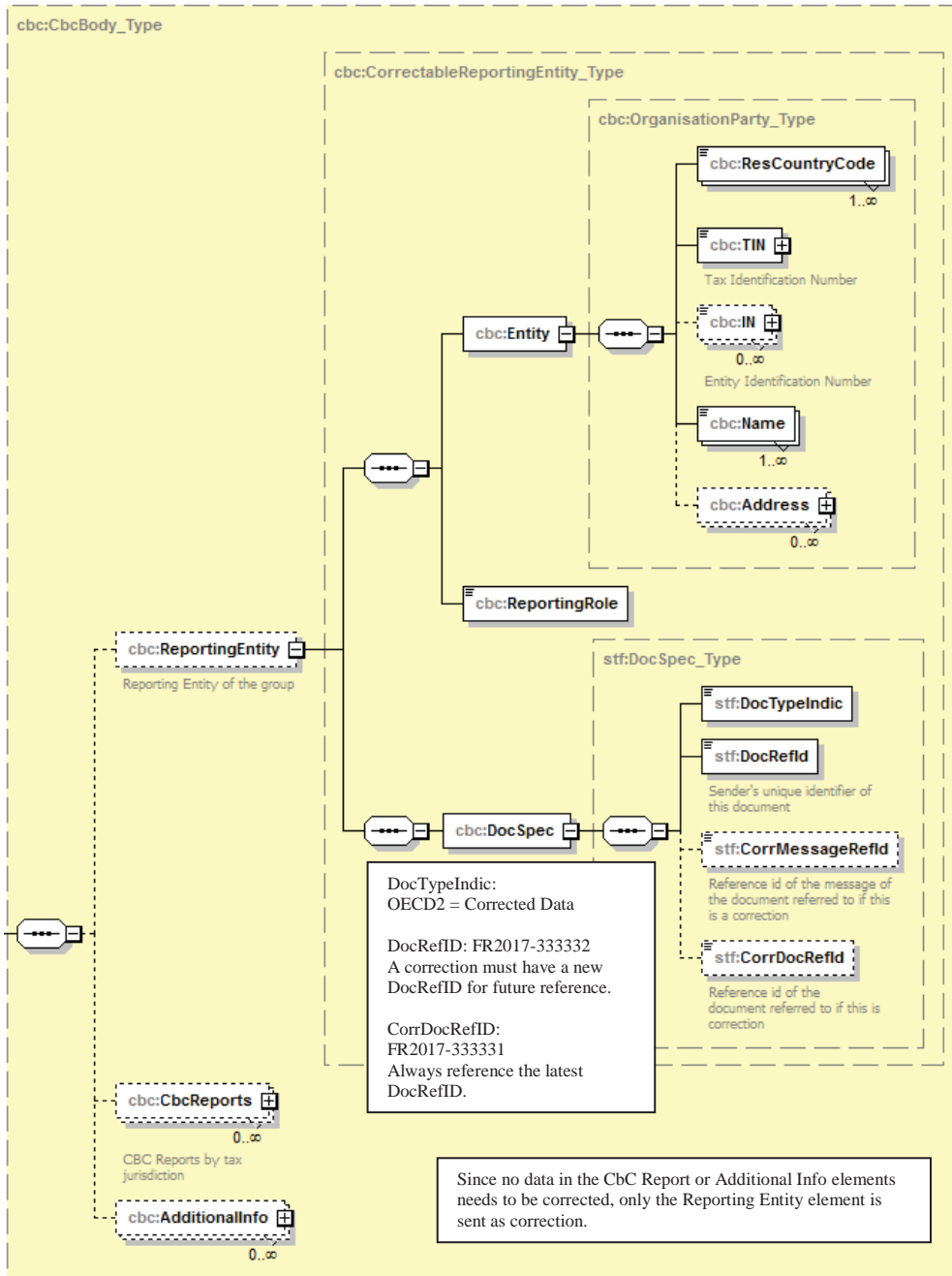

Fourth example: a correction is made only with respect to the Additional Info; no CbC Report or Reporting Entity data needs to be corrected. The correction must reference the Additional Info to be corrected, via its DocRefID (in this example, assume the previous Additional Info DocRefID was FR2017-444441).

MessageRefID: FR2017-FranceNationalPart00004.

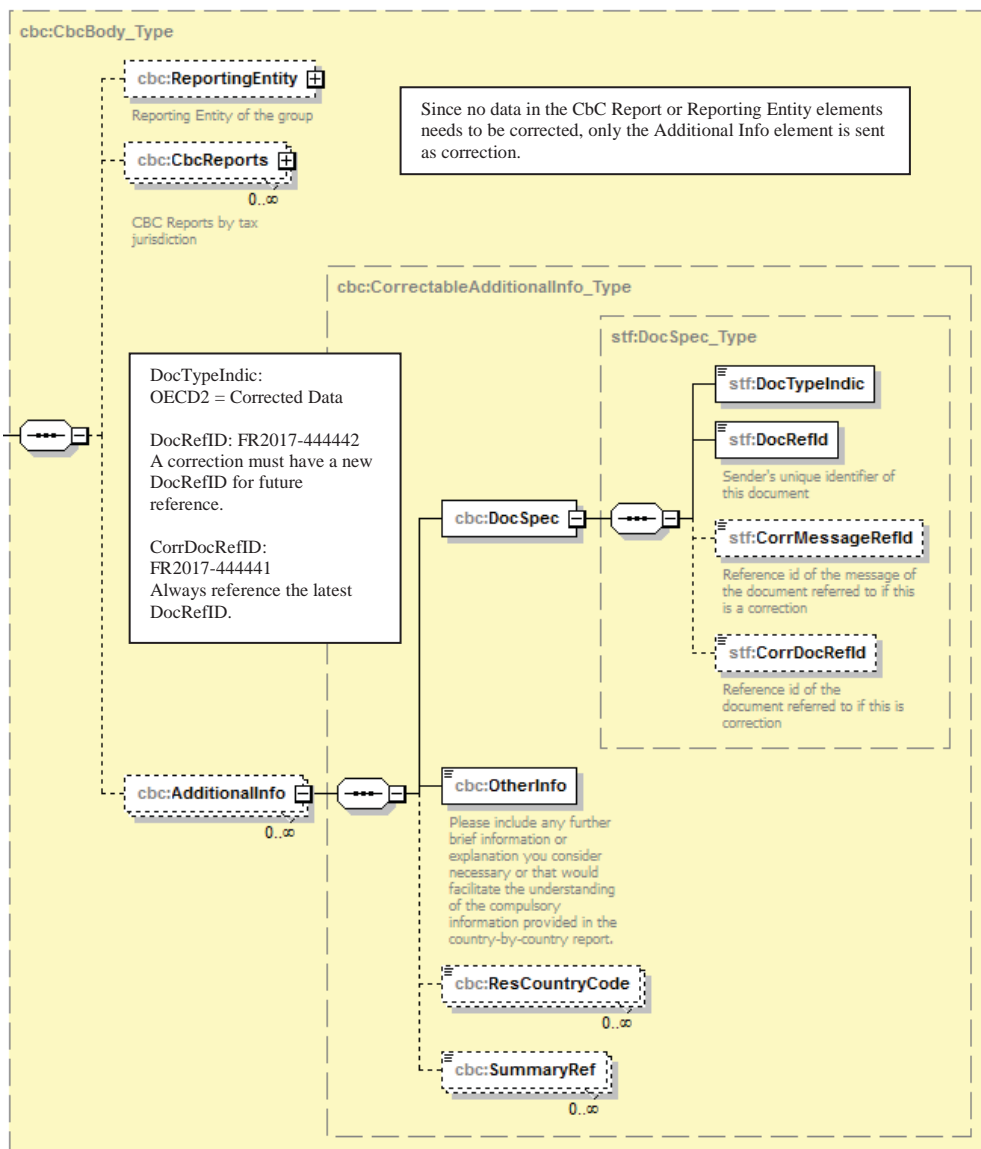

Appendix A: CbC XML Schema V1.0.1 Diagrams

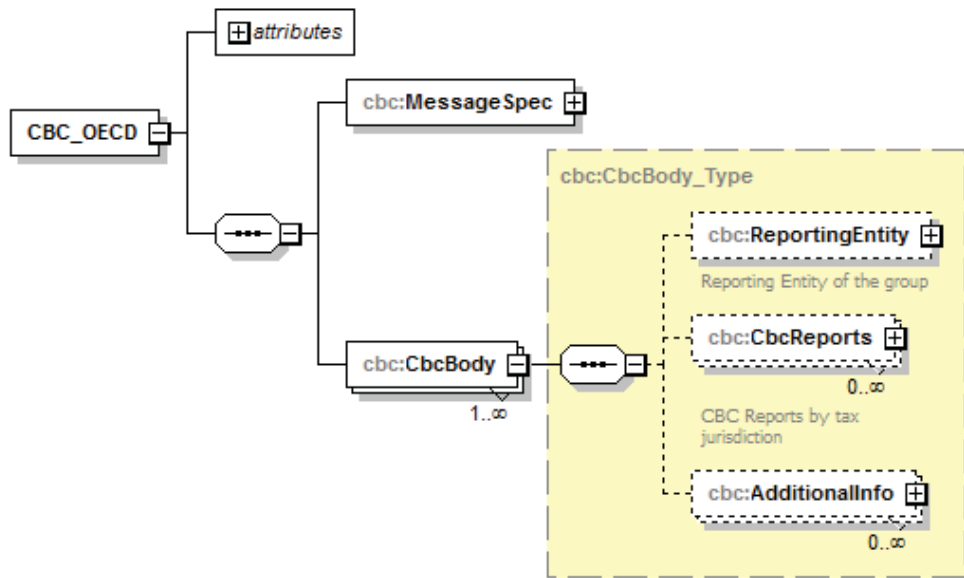

Generated by XMLSpy

www.altova.com

Message Header [Section I]

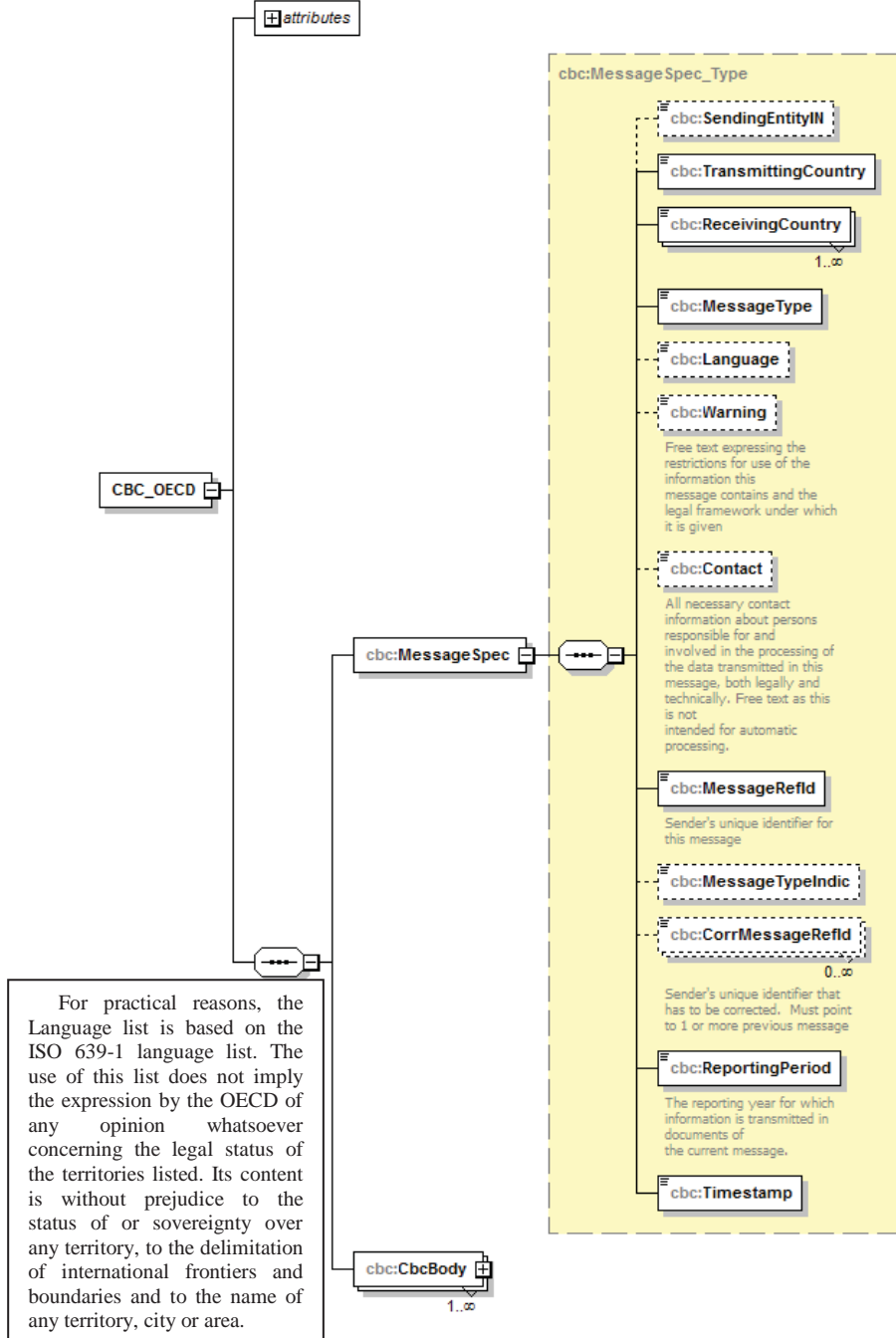

Reporting Entity [Section IIIa]

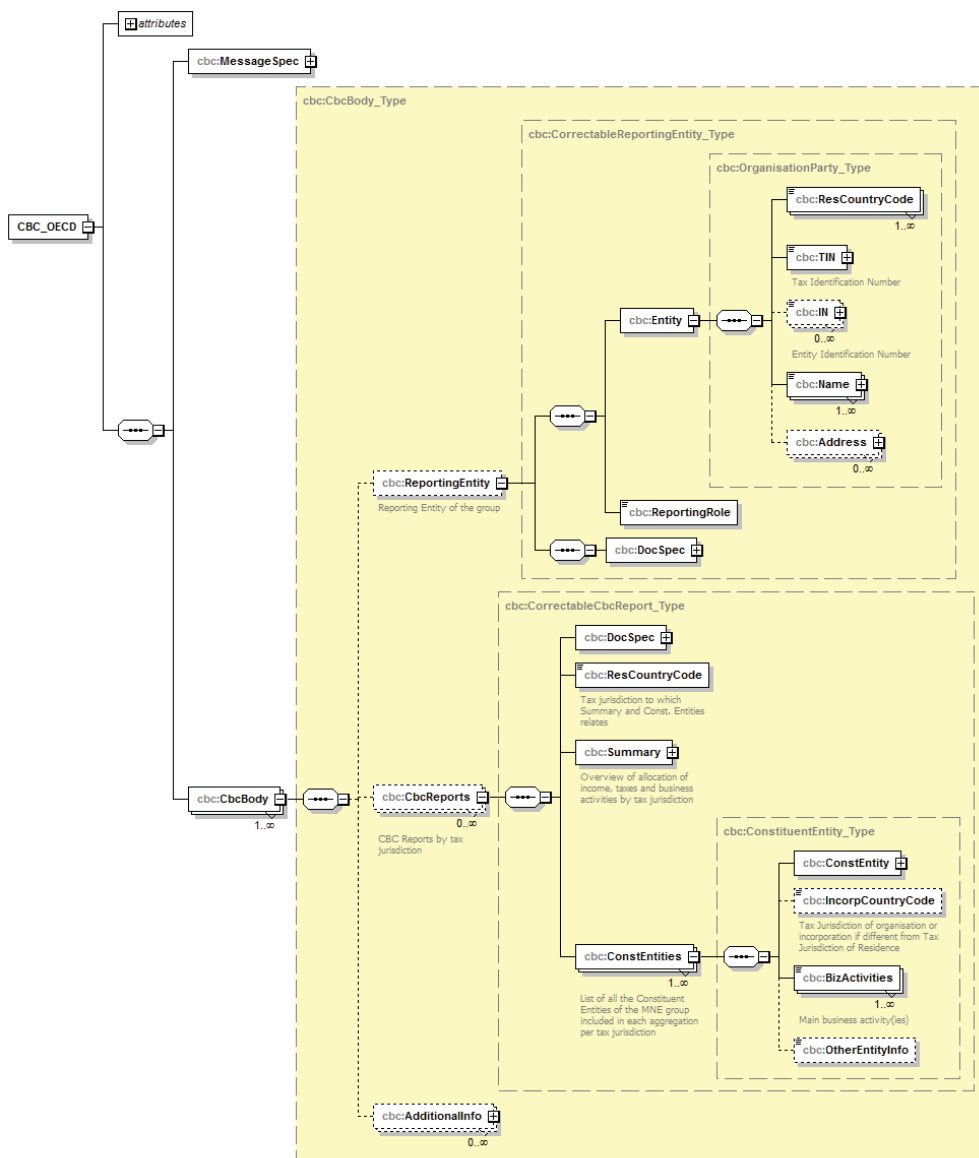

Generated by XMLSpy www.altova.com

Address Type [Section II]

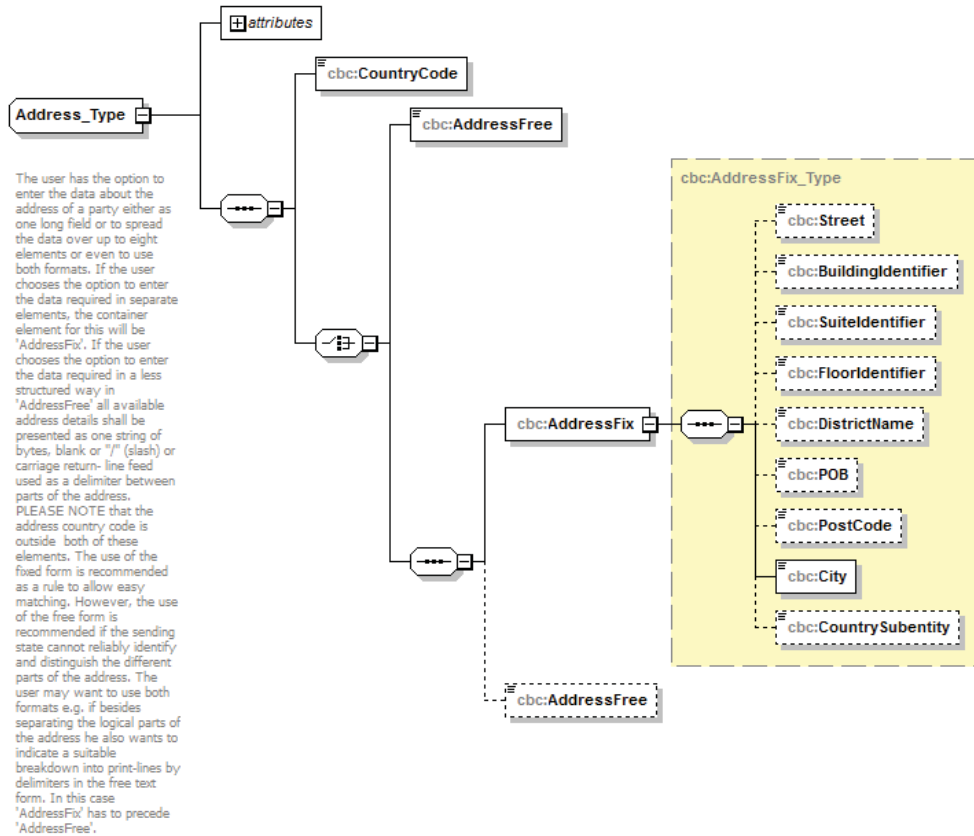

Generated by XMLSpy

www.altova.com

Organisation Party Type [Section II]

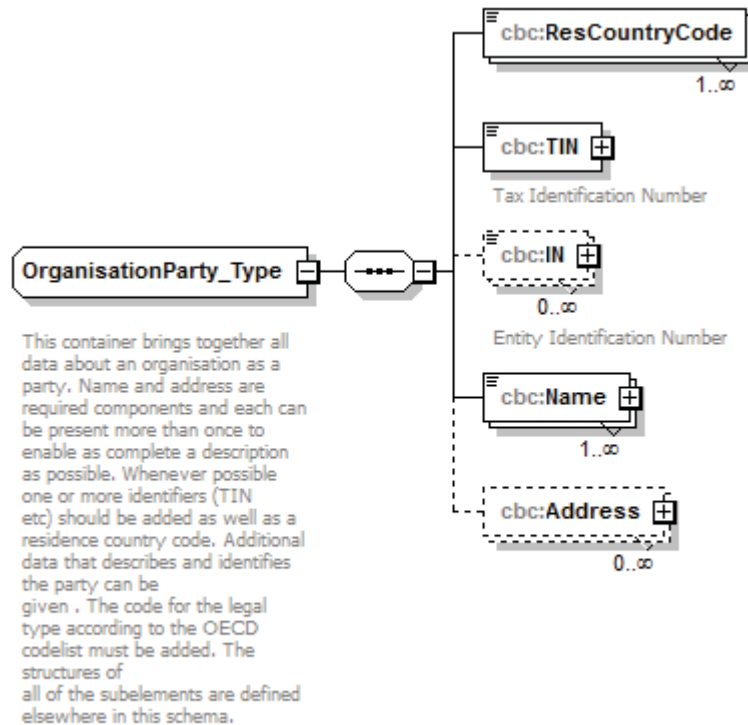

Generated by XMLSpy

www.altova.com

For practical reasons, the ResCountryCode list is based on the ISO 3166-1 country list, complemented by the X5 code for stateless entities and income. The use of this list does not imply the expression by the OECD of any opinion whatsoever concerning the legal status of the territories listed. Its content is without prejudice to the status of or sovereignty over any territory, to the delimitation of international frontiers and boundaries and to the name of any territory, city or area.

Appendix B: Glossary of namespaces

CbC XML Schema Namespaces

| Namespace | Description | Filename |
|-----------|--------------------------------------|------------------------|
| cbc | CbC types | CbcXML_v1.0.1.xsd |
| stf | OECD Common types | oecdtypes_v4.1.xsd |
| iso | ISO types (Country & Currency codes) | isocbctypes_v1.0.1.xsd |

Appendix C: Template for the Country-by-Country Report

Table 1. Overview of allocation of income, taxes and business activities by tax jurisdiction

| Name of the MNE group: Fiscal year concerned: Currency: | | | | | | | | | | |
|---|--------------------|------------------|-------|---|--|---|-------------------|-------------------------|------------------------|---|
| Tax Jurisdiction | Revenues | | | Profit (Loss) Before Income Tax | Income Tax Paid (on cash basis) | Income Tax Accrued – Current Year | Stated capital | Accumulated earnings | Number of Employees | Tangible Assets other than Cash and Cash Equivalents |
| | Unrelated Party | Related Party | Total | | | | | | | |
| | | | | | | | | | | |
| | | | | | | | | | | |
| | | | | | | | | | | |

Table 3. Additional Information

| |
|--|
| <p>Name of the MNE group: Fiscal year concerned:</p> <p>Please include any further brief information or explanation you consider necessary or that would facilitate the understanding of the compulsory information provided in the country-by-country report.</p> |
|--|

ORGANISATION FOR ECONOMIC CO-OPERATION AND DEVELOPMENT

The OECD is a unique forum where governments work together to address the economic, social and environmental challenges of globalisation. The OECD is also at the forefront of efforts to understand and to help governments respond to new developments and concerns, such as corporate governance, the information economy and the challenges of an ageing population. The Organisation provides a setting where governments can compare policy experiences, seek answers to common problems, identify good practice and work to co-ordinate domestic and international policies.

The OECD member countries are: Australia, Austria, Belgium, Canada, Chile, the Czech Republic, Denmark, Estonia, Finland, France, Germany, Greece, Hungary, Iceland, Ireland, Israel, Italy, Japan, Korea, Latvia, Luxembourg, Mexico, the Netherlands, New Zealand, Norway, Poland, Portugal, the Slovak Republic, Slovenia, Spain, Sweden, Switzerland, Turkey, the United Kingdom and the United States. The European Union takes part in the work of the OECD.

OECD Publishing disseminates widely the results of the Organisation's statistics gathering and research on economic, social and environmental issues, as well as the conventions, guidelines and standards agreed by its members.



For more information:

 ctp.beps@oecd.org

 www.oecd.org/tax/beps

 [@OECDtax](https://twitter.com/OECDtax)
